

NARROW

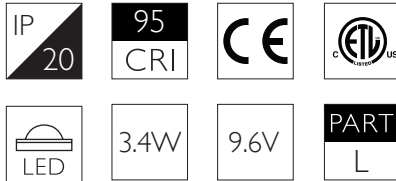

TECHNICAL DESCRIPTION

Stacko Tilt Fixed Mid is a 3.4W miniature display orientated LED lighting module that is a part of the modular Stacko Collection which allows users to 'stack' lighting modules together to create unique lighting set-ups that comes as standard in white, black and brushed aluminium finishes. It is a 'Mid' Stacko lighting module which means it cannot close a circuit and accepts another Stacko lighting module above it. It has a total of 3 light engines with a combined output of 306lm. Each 102lm light engine produces a Narrow beam with a peak intensity of 794 cd. It has a fixed tilt angle of 35 degrees. Stacko Tilt Fixed Mid is infinitely adjustable in 360 degree pan. The luminaire is compatible with our Minipoint system that enables a plug and play setup where luminaires can be simply swapped to suit changing lighting requirements. Please note that there can only be maximum 10 light engines per Stacko circuit or driver.

MECHANICAL & ELECTRICAL

CATEGORY Interior use only IP20

MATERIAL AL 6063-T6

WEIGHT 105g

PAN 360°

TILT Fixed 35° tilt angle

ACCESSORIES End cap

SYSTEMS Minipoint

DRIVER TYPE Constant Current

FORWARD VOLTAGE 9.6V

CURRENT 350mA

DIMMING COMPATIBILITY DALI | 0-10V

CIRCUIT Open

NO. OF LIGHT ENGINES 3

FINISHES

FINISHES Brushed Aluminium | Black | White | Rubbed Bronze* | Polished Brass* | Satin Brass* | Polished Nickel* | Custom RAL**

* All Premium or Custom finishes are built and finished to order. These are subject to an extended lead time and MOQ

OPTICAL

PER LIGHT ENGINE OUTPUT

MODULE OUTPUT 102lm**

ABSOLUTE OUTPUT 94lm

BEAM ANGLE 16°

SYSTEM POWER 3.4W

COLOUR TEMPERATURE 2700K | 3000K*

CRI 95CRI

TM-30 Rf 93 | Rg 99

LOR 92%

TOTAL COMBINED OUTPUT

MODULE OUTPUT 306lm**

ABSOLUTE OUTPUT 282lm

** Photometry shown is correct for 3000K module. Please enquire for 2700K module output.

PHOTOMETRY PER LIGHT ENGINE

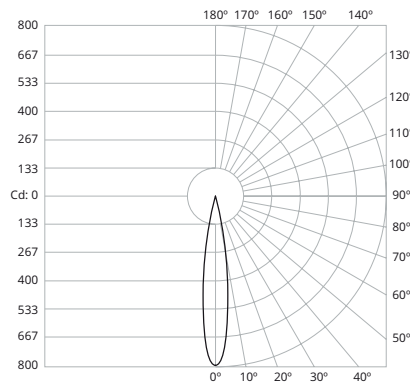

Distance (m)	Beam Diameter (m)	1.0W 16° (lx)	3000K LED (lx)
0.25	0.07		12,701
0.50	0.14		3,175
1.00	0.28	794	
2.00	0.56	198	
3.00	0.84	88	

Brushed Aluminium	White 9010	Matte Anodised Black	Rubbed Bronze *	Polished Brass *	Brushed Brass *	Polished Nickel *
I003-M-AL-XX9516	I003-M-WH-XX9516	I003-M-EBA-XX9516	I003-M-RB-XX9516	I003-M-PB-XX9516	I003-M-SB-XX9516	I003-M-PN-XX9516

For 3000K Substitute XX with 30

-

For 2700K Substitute XX with 27

All variants of Stacko require a Minipoint for mounting.

Please enquire for Custom RAL finishes.

*Premium finishes subject to MOQ & extended lead times.

MEDIUM

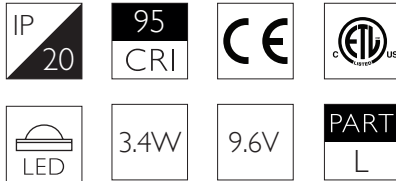

TECHNICAL DESCRIPTION

Stacko Tilt Fixed Mid is a 3.4W miniature display orientated LED lighting module that is a part of the modular Stacko Collection which allows users to 'stack' lighting modules together to create unique lighting set-ups that comes as standard in white, black and brushed aluminium finishes. It is a 'Mid' Stacko lighting module which means it cannot close a circuit and accepts another Stacko lighting module above it. It has a total of 3 light engines with a combined output of 306lm. Each 102lm light engine produces a Medium beam with a peak intensity of 359 cd. It has a fixed tilt angle of 35 degrees. Stacko Tilt Fixed Mid is infinitely adjustable in 360 degree pan. The luminaire is compatible with our Minipoint system that enables a plug and play setup where luminaires can be simply swapped to suit changing lighting requirements. Please note that there can only be maximum 10 light engines per Stacko circuit or driver.

MECHANICAL & ELECTRICAL

CATEGORY Interior use only IP20
MATERIAL AL 6063-T6
WEIGHT 105g
PAN 360°
TILT Fixed 35° tilt angle
ACCESSORIES End cap

SYSTEMS Minipoint
DRIVER TYPE Constant Current
FORWARD VOLTAGE 9.6V
CURRENT 350mA
DIMMING COMPATIBILITY DALI | 0-10V
CIRCUIT Open
NO. OF LIGHT ENGINES 3

FINISHES

FINISHES Brushed Aluminium | Black | White | Rubbed Bronze* | Polished Brass* | Satin Brass* | Polished Nickel* | Custom RAL**

* All Premium or Custom finishes are built and finished to order. These are subject to an extended lead time and MOQ

OPTICAL

PER LIGHT ENGINE OUTPUT

MODULE OUTPUT 102lm**
ABSOLUTE OUTPUT 94lm

BEAM ANGLE 23°
SYSTEM POWER 3.4W
COLOUR TEMPERATURE 2700K | 3000K*
CRI 95CRI
TM-30 Rf 93 | Rg 99
LOR 92%

TOTAL COMBINED OUTPUT

MODULE OUTPUT 306lm**
ABSOLUTE OUTPUT 282lm

** Photometry shown is correct for 3000K module. Please enquire for 2700K module output.

PHOTOMETRY PER LIGHT ENGINE

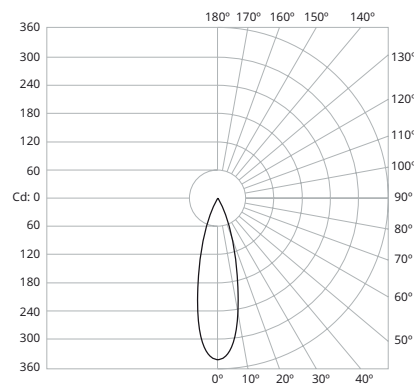

Distance (m)	Beam Diameter (m)	Illuminance (lx)
0.25	0.10	5,745
0.50	0.20	1,436
1.00	0.41	359
2.00	0.81	90
3.00	1.22	40

Brushed Aluminium	White 9010	Matte Anodised Black	Rubbed Bronze *	Polished Brass *	Brushed Brass *	Polished Nickel *
I003-M-AL-XX9523	I003-M-WH-XX9523	I003-M-EBA-XX9523	I003-M-RB-XX9523	I003-M-PB-XX9523	I003-M-SB-XX9523	I003-M-PN-XX9523

For 3000K Substitute XX with 30

For 2700K Substitute XX with 27

All variants of Stacko require a Minipoint for mounting.

Please enquire for Custom RAL finishes.

*Premium finishes subject to MOQ & extended lead times.

FLOOD

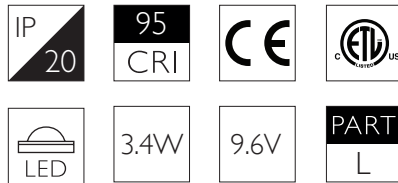

TECHNICAL DESCRIPTION

Stacko Tilt Fixed Mid is a 3.4W miniature display orientated LED lighting module that is a part of the modular Stacko Collection which allows users to 'stack' lighting modules together to create unique lighting set-ups that comes as standard in white, black and brushed aluminium finishes. It is a 'Mid' Stacko lighting module which means it cannot close a circuit and accepts another Stacko lighting module above it. It has a total of 3 light engines with a combined output of 306lm. Each 102lm light engine produces a Flood beam with a peak intensity of 109 cd. It has a fixed tilt angle of 35 degrees. Stacko Tilt Fixed Mid is infinitely adjustable in 360 degree pan. The luminaire is compatible with our Minipoint system that enables a plug and play setup where luminaires can be simply swapped to suit changing lighting requirements. Please note that there can only be maximum 10 light engines per Stacko circuit or driver.

MECHANICAL & ELECTRICAL

CATEGORY Interior use only IP20
MATERIAL AL 6063-T6
WEIGHT 105g
PAN 360°
TILT Fixed 35° tilt angle
ACCESSORIES End cap

SYSTEMS Minipoint
DRIVER TYPE Constant Current
FORWARD VOLTAGE 9.6V
CURRENT 350mA
DIMMING COMPATIBILITY DALI | 0-10V
CIRCUIT Open
NO. OF LIGHT ENGINES 3

FINISHES

FINISHES Brushed Aluminium | Black | White | Rubbed Bronze* | Polished Brass* | Satin Brass* | Polished Nickel* | Custom RAL**

* All Premium or Custom finishes are built and finished to order. These are subject to an extended lead time and MOQ

OPTICAL

PER LIGHT ENGINE OUTPUT

MODULE OUTPUT 102lm**
ABSOLUTE OUTPUT 94lm

BEAM ANGLE 45°
SYSTEM POWER 3.4W
COLOUR TEMPERATURE 2700K | 3000K*
CRI 95CRI
TM-30 Rf 93 | Rg 99
LOR 92%

TOTAL COMBINED OUTPUT

MODULE OUTPUT 306lm**
ABSOLUTE OUTPUT 282lm

** Photometry shown is correct for 3000K module. Please enquire for 2700K module output.

PHOTOMETRY PER LIGHT ENGINE

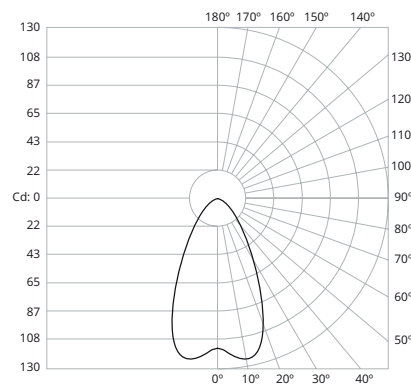

Distance (m)	Beam Diameter (m)	Illuminance (lx)
0.25	0.21	1,744
0.50	0.41	436
1.00	0.83	109
2.00	1.66	27
3.00	2.49	12

Brushed Aluminium	White 9010	Matte Anodised Black	Rubbed Bronze *	Polished Brass *	Brushed Brass *	Polished Nickel *
I003-M-AL-XX9545	I003-M-WH-XX9545	I003-M-EBA-XX9545	I003-M-RB-XX9545	I003-M-PB-XX9545	I003-M-SB-XX9545	I003-M-PN-XX9545

For 3000K Substitute XX with 30

For 2700K Substitute XX with 27

All variants of Stacko require a Minipoint for mounting.

Please enquire for Custom RAL finishes.

*Premium finishes subject to MOQ & extended lead times.

WIDE FLOOD

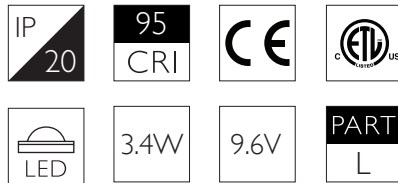

TECHNICAL DESCRIPTION

Stacko Tilt Fixed Mid is a 3.4W miniature display orientated LED lighting module that is a part of the modular Stacko Collection which allows users to 'stack' lighting modules together to create unique lighting set-ups that comes as standard in white, black and brushed aluminium finishes. It is a 'Mid' Stacko lighting module which means it cannot close a circuit and accepts another Stacko lighting module above it. It has a total of 3 light engines with a combined output of 306lm. Each 102lm light engine produces a Wide flood beam with a peak intensity of 26 cd. It has a fixed tilt angle of 35 degrees. Stacko Tilt Fixed Mid is infinitely adjustable in 360 degree pan. The luminaire is compatible with our Minipoint system that enables a plug and play setup where luminaires can be simply swapped to suit changing lighting requirements. Please note that there can only be maximum 10 light engines per Stacko circuit or driver.

MECHANICAL & ELECTRICAL

CATEGORY Interior use only IP20
MATERIAL AL 6063-T6
WEIGHT 105g
PAN 360°
TILT Fixed 35° tilt angle
ACCESSORIES End cap

SYSTEMS Minipoint
DRIVER TYPE Constant Current
FORWARD VOLTAGE 9.6V
CURRENT 350mA
DIMMING COMPATIBILITY DALI | 0-10V
CIRCUIT Open
NO. OF LIGHT ENGINES 3

FINISHES

FINISHES Brushed Aluminium | Black | White | Rubbed Bronze* | Polished Brass* | Satin Brass* | Polished Nickel* | Custom RAL**

* All Premium or Custom finishes are built and finished to order. These are subject to an extended lead time and MOQ

OPTICAL

PER LIGHT ENGINE OUTPUT

MODULE OUTPUT 102lm**
ABSOLUTE OUTPUT 94lm

BEAM ANGLE 90°
SYSTEM POWER 3.4W
COLOUR TEMPERATURE 2700K | 3000K*
CRI 95CRI
TM-30 Rf 93 | Rg 99
LOR 92%

TOTAL COMBINED OUTPUT

MODULE OUTPUT 306lm**
ABSOLUTE OUTPUT 282lm

** Photometry shown is correct for 3000K module. Please enquire for 2700K module output.

PHOTOMETRY PER LIGHT ENGINE

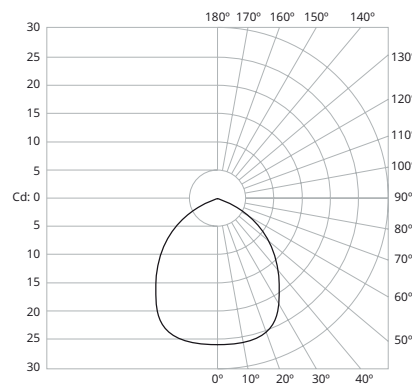

1.0W 90°		3000K LED	
0.25m	0.50m	416 lx	
0.50m	1.00m	104 lx	
1.00m	2.00m	26 lx	
2.00m	4.00m	7 lx	
3.00m	6.00m	3 lx	

Brushed Aluminium	White 9010	Matte Anodised Black	Rubbed Bronze *	Polished Brass *	Brushed Brass *	Polished Nickel *
I003-M-AL-XX9590	I003-M-WH-XX9590	I003-M-EBA-XX9590	I003-M-RB-XX9590	I003-M-PB-XX9590	I003-M-SB-XX9590	I003-M-PN-XX9590

For 3000K Substitute XX with 30

-

For 2700K Substitute XX with 27

All variants of Stacko require a Minipoint for mounting.

Please enquire for Custom RAL finishes.

*Premium finishes subject to MOQ & extended lead times.

DIMENSIONS

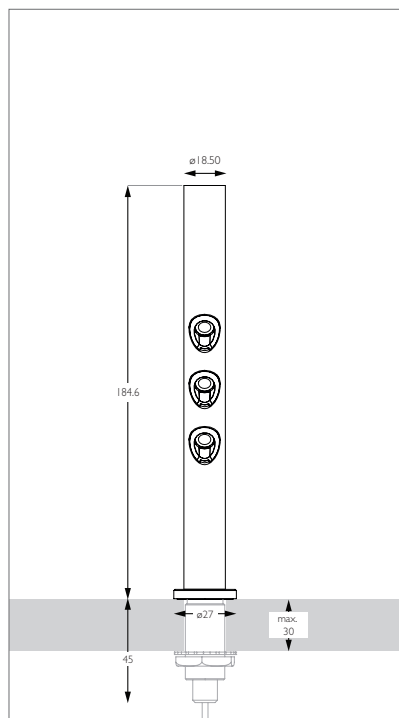

INSIDE MINIPOINT

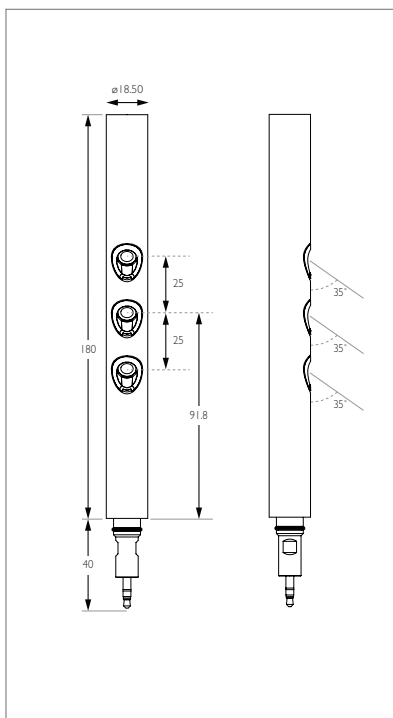

LIGHTING MODULE ONLY

SYSTEM INFO

HORIZONTAL STACK Do not exceed 3 luminaire modules / 1000mm / 10 light engines (whichever comes first) without installing a form of support.

VERTICAL STACK Do not exceed 5 luminaire modules / 1000mm / 10 light engines (whichever comes first) without installing a form of support.